

Rev	Note	CreatedBy	Appr.By	Appr.Date
A	Initial release	FG	AE	2020-05-27

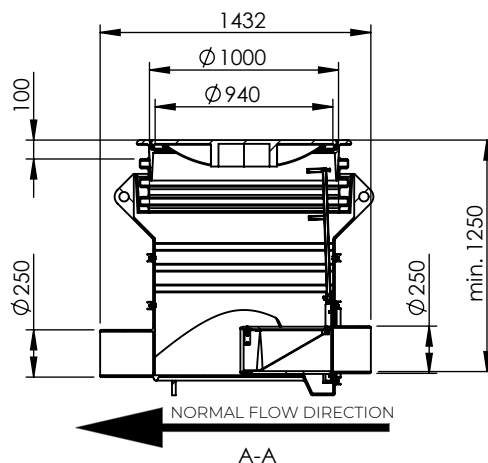

**Option 1:**

- DN1000 Riser pipe with cover  
(not included in base price)
- min. height 1250mm

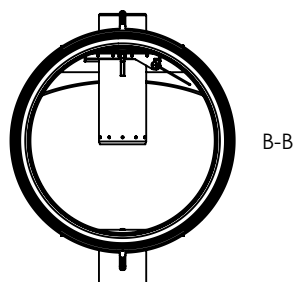
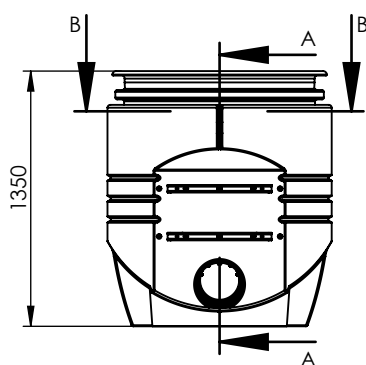
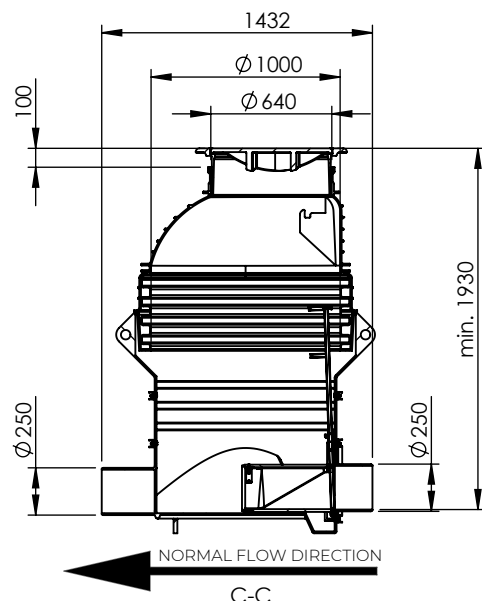
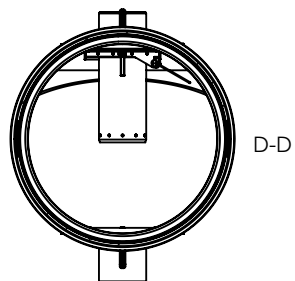
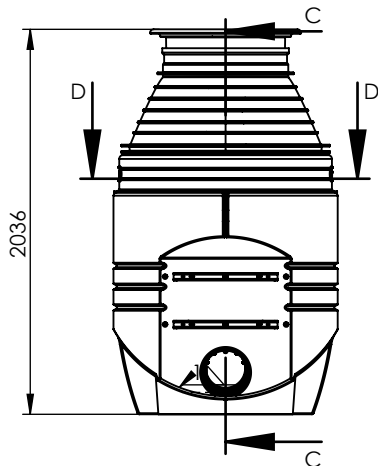

**Option 2:**

- DN1000 riser pipe with cone and cover  
(not included in base price)
- min. height 1930mm

© 2018 Wapro AB. This document is subject to copyrights owned by Wapro AB. Any amendments, republication, retransmission, and/or reproduction of all or any part of the document is expressly prohibited, unless the copyright owner of the material has expressly granted its prior written consent. All other rights are reserved.

Designed By FG	Approved By AE	Created Date 2020-05-27	Units [mm]	General Tolerance SS-ISO 2768-1 m	Scale 1:40	
Material PE, PVC, EN1.4301, MVQ			Project			
Weight [kg] 363.2		Box Volume [m³]	Description WaStop Access DN250 Large			
 www.wapro.com			Riser pipe DN1000 with cover, alt. riser pipe with cone			
			Article Number WS250-WA1000-S	Drawing Number ws250-wa1000-en	Rev A	Sheet 1 (1)